

T-1^{3/4} (5 mm), T-1 (3 mm), Low Current LED Lamps

Technical Data

HLMP-4700, -4719, -4740
HLMP-1700, -1719, -1790

Features

- Low Power
- High Efficiency
- CMOS-MOS Compatible
- TTL Compatible
- Wide Viewing Angle
- Choice of Package Styles
- Choice of Colors

Applications

- Low Power DC Circuits
- Telecommunications Indicators

- Portable Equipment
- Keyboard Indicators

Description

These tinted diffused LED lamps are designed and optimized specifically for low DC current operation. Luminous intensity and forward voltage are tested at 2 mA to assure consistent brightness at TTL output current levels.

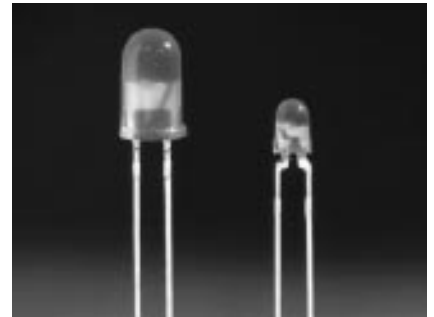

Package Dimensions

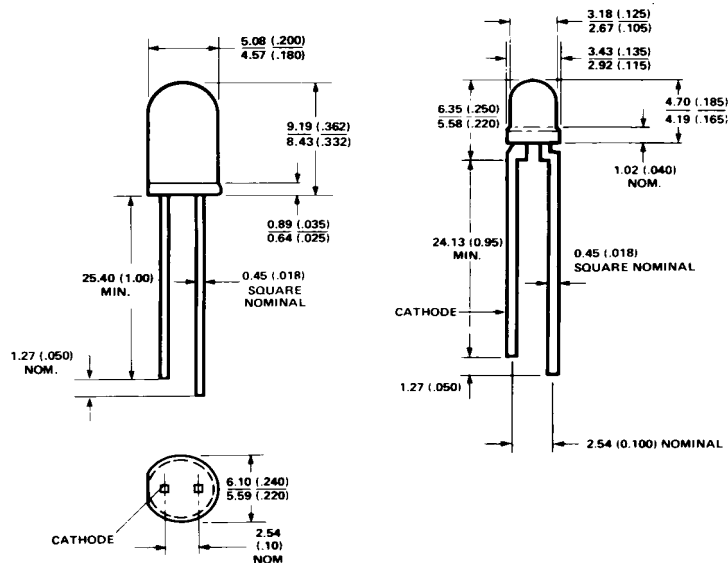

HLMP-4700, -4719, -4740

A

HLMP-1700, -1719, -1790

B

NOTES:
 1. ALL DIMENSIONS ARE IN MILLIMETRES (INCHES).
 2. AN EPOXY MINISCUS MAY EXTEND ABOUT 1 mm (0.040") DOWN THE LEADS.

Selection Guide

| Package Description | Color | Device HLMP- | Luminous Intensity I_v (mcd) at 2 mA | | | $2\theta^{1/2}$ | Package Outline |
|-------------------------|---------------------|--------------|---|------|------|-----------------|-----------------|
| | | | Min. | Typ. | Max. | | |
| T-1 3/4 Tinted Diffused | Red | 4700 | 1.5 | 2.3 | – | 50 | A |
| | | 4700-C00xx | 1.5 | 2.3 | – | | |
| | | 4700-CD0FH | 1.5 | 2.3 | 4.2 | | |
| | Yellow | 4719 | 0.9 | 2.1 | – | | |
| | | 4719-A00xx | 0.9 | 2.1 | – | | |
| | Green | 4740 | 1.0 | 2.3 | – | | |
| | | 4740-A00xx | 1.0 | 2.3 | – | | |
| | | 4740-AB000 | 1.0 | 2.3 | 3.2 | | |
| | T-1 Tinted Diffused | Red | 1700 | 0.8 | 2.1 | | |
| 1700-B00xx | | | 0.8 | 2.1 | – | | |
| Yellow | | 1719 | 0.9 | 2.1 | – | | |
| | | 1719-A00xx | 0.9 | 2.1 | – | | |
| | | 1719-ABB00 | 0.9 | 2.1 | 2.8 | | |
| Green | | 1790 | 1.0 | 2.3 | – | | |
| | | 1790-A00xx | 1.0 | 2.3 | – | | |
| | | 1790-AB0FH | 1.0 | 2.4 | 3.2 | | |

Note:

1. $\theta^{1/2}$ is the typical off-axis angle at which the luminous intensity is half the axial luminous intensity.

Part Numbering System

HLMP-X 7 XX - X X X XX

Mechanical Option

00: Bulk
 01: Tape & Reel, Crimped Leads
 02, BH: Tape & Reel, Straight Leads
 A1, B1: Right Angle Housing, Uneven Leads
 A2, B2: Right Angle Housing, Even Leads
 FH: 2 Iv bins select with Inventory Control

Color Bin Options

0: Full color bin distribution
 B: Color bins 2 & 3 only

Maximum Iv Bin Options

0: Open (No. max. limit)
 Others: Please refer to the Iv bin Table

Minimum Iv Bin Options

Please refer to the Iv Bin Table

Color Option

00: GaP HER
 19: GaP Yellow
 40: GaP Green
 90: GaP Green

Package Options

4: T-1^{3/4} (5 mm)
 1: T-1 (3 mm)

Electrical/Optical Characteristics at $T_A = 25^\circ\text{C}$

| Symbol | Description | T-1 ^{3/4} | T-1 | Min. | Typ. | Max. | Units | Test Conditions |
|-----------------------|---------------------------|----------------------|----------------------|-------------------|--|-------------------|-----------------------|------------------------------------|
| V_F | Forward Voltage | 4700 4719 4740 | 1700 1719 1790 | | 1.7 1.8 1.9 | 2.0 2.5 2.2 | V | 2 mA |
| V_R | Reverse Breakdown Voltage | 4700 4719 4740 | 1700 1719 1790 | 5.0 5.0 5.0 | | | V | $I_R = 50 \mu\text{A}$ |
| λ_d | Dominant Wavelength | 4700 4719 4740 | 1700 1719 1790 | | 626 585 569 | | nm | Note 1 |
| $\Delta\lambda_{1/2}$ | Spectral Line Halfwidth | 4700 4719 4740 | 1700 1719 1790 | | 40 36 28 | | nm | |
| τ_S | Speed of Response | 4700 4719 4740 | 1700 1719 1790 | | 90 90 500 | | ns | |
| C | Capacitance | 4700 4719 4740 | 1700 1719 1790 | | 11 15 18 | | pF | $V_F = 0$, $f = 1 \text{ MHz}$ |
| $R\theta_{J-PIN}$ | Thermal Resistance | 4700 4719 4740 | 1700 1719 1790 | | 260 ^[3] 290 ^[4] | | $^\circ\text{C/W}$ | Junction to Cathode Lead |
| λ_{PEAK} | Peak Wavelength | 4700 4719 4740 | 1700 1719 1790 | | 635 583 565 | | nm | Measurement at peak |
| η_V | Luminous Efficacy | 4700 4719 4740 | 1700 1719 1790 | | 145 500 595 | | <u>lumens</u> watt | Note 2 |

Notes:

1. The dominant wavelength, λ_d , is derived from the CIE chromaticity diagram and represents the single wavelength which defines the color of the device.
2. The radiant intensity, I_e , in watts per steradian, may be found from the equation $I_e = I_v/\eta_V$, where I_v is the luminous intensity in candelas and η_V is luminous efficacy in lumens/watt.
3. T-1^{3/4}.
4. T-1.

Absolute Maximum Ratings

| Parameter | Maximum Rating | | Units |
|---|------------------------|----------------------------------|-------|
| Power Dissipation (Derate linearly from 92°C at 1.0 mA/°C) | Red Yellow Green | 24 36 24 | mW |
| DC and Peak Forward Current | 7 | | mA |
| Transient Forward Current (10 μs Pulse) ^[1] | 500 | | mA |
| Reverse Voltage ($I_R = 50 \mu A$) | 5.0 | | V |
| Operating Temperature Range | Red/Yellow Green | -55°C to 100°C -20°C to 100°C | |
| Storage Temperature Range | -55°C to +100°C | | |
| Lead Soldering Temperature [1.6 mm (0.063 in.) from body] | 260°C for 5 seconds | | |

Note:

- The transient peak current is the maximum non-recurring peak current the devices can withstand without damaging the LED die and wire bonds. It is not recommended that the device be operated at peak currents beyond the Absolute Maximum Peak Forward Current.

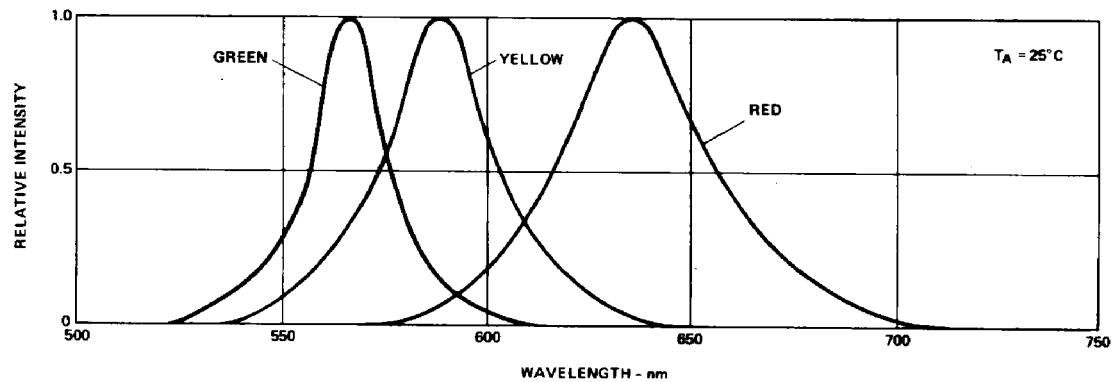

Figure 1. Relative Intensity vs. Wavelength.

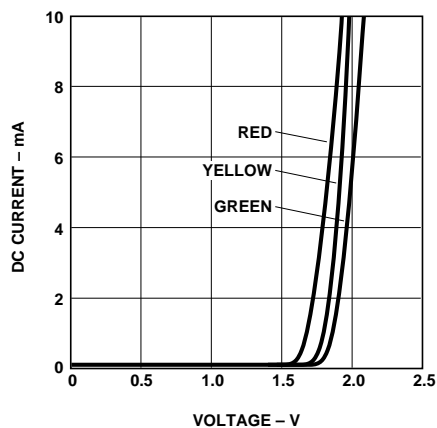

Figure 2. Forward Current vs. Forward Voltage.

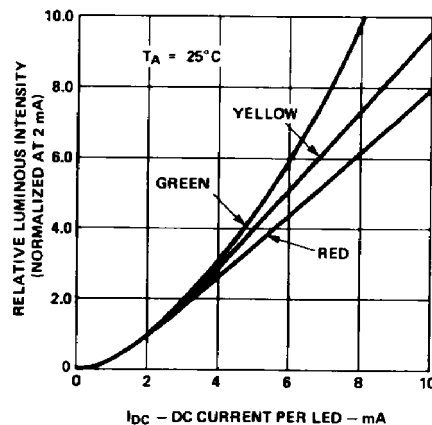

Figure 3. Relative Luminous Intensity vs. Forward Current.

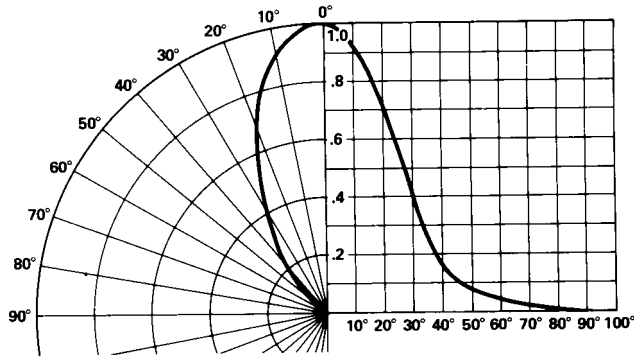

Figure 4. Relative Luminous Intensity vs. Angular Displacement for T-1^{3/4} Lamp.

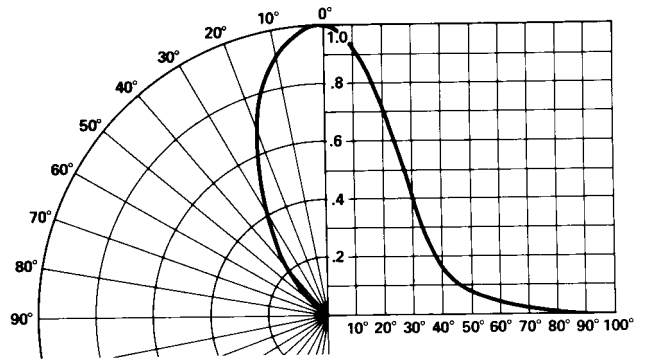

Figure 5. Relative Luminous Intensity vs. Angular Displacement for T-1 Lamp.

Intensity Bin Limits

| Color | Bin | Intensity Range (mcd) | |
|-------|---------|-----------------------|--------|
| | | Min. | Max. |
| Red | B | 0.9 | 1.5 |
| | C | 1.5 | 2.4 |
| | D | 2.4 | 3.8 |
| | E | 3.8 | 6.1 |
| | F | 6.1 | 9.7 |
| | G | 9.7 | 15.5 |
| | H | 15.5 | 24.8 |
| | I | 24.8 | 39.6 |
| | J | 39.6 | 63.4 |
| | K | 63.4 | 101.5 |
| | L | 101.5 | 162.4 |
| | M | 162.4 | 234.6 |
| | N | 234.6 | 340.0 |
| | O | 340.0 | 540.0 |
| | P | 540.0 | 850.0 |
| | Q | 850.0 | 1200.0 |
| | R | 1200.0 | 1700.0 |
| | S | 1700.0 | 2400.0 |
| | T | 2400.0 | 3400.0 |
| | U | 3400.0 | 4900.0 |
| V | 4900.0 | 7100.0 | |
| W | 7100.0 | 10200.0 | |
| X | 10200.0 | 14800.0 | |
| Y | 14800.0 | 21400.0 | |
| Z | 21400.0 | 30900.0 | |

Maximum tolerance for each bin limit is $\pm 18\%$.

Intensity Bin Limits, continued

| Color | Bin | Intensity Range (mcd) | |
|--------------|------------|------------------------------|-------------|
| | | Min. | Max. |
| Yellow | A | 1.0 | 1.6 |
| | B | 1.6 | 2.5 |
| | C | 2.5 | 4.0 |
| | D | 4.0 | 6.5 |
| | E | 6.5 | 10.3 |
| | F | 10.3 | 16.6 |
| | G | 16.6 | 26.5 |
| | H | 26.5 | 42.3 |
| | I | 42.3 | 67.7 |
| | J | 67.7 | 108.2 |
| | K | 108.2 | 173.2 |
| | L | 173.2 | 250.0 |
| | M | 250.0 | 360.0 |
| | N | 360.0 | 510.0 |
| | O | 510.0 | 800.0 |
| | P | 800.0 | 1250.0 |
| | Q | 1250.0 | 1800.0 |
| R | 1800.0 | 2900.0 | |
| S | 2900.0 | 4700.0 | |
| T | 4700.0 | 7200.0 | |
| U | 7200.0 | 11700.0 | |
| V | 11700.0 | 18000.0 | |
| W | 18000.0 | 27000.0 | |

Maximum tolerance for each bin limit is $\pm 18\%$.

Intensity Bin Limits, continued

| Color | Bin | Intensity Range (mcd) | |
|--------------|------------|------------------------------|-------------|
| | | Min. | Max. |
| Green | A | 1.1 | 1.8 |
| | B | 1.8 | 2.9 |
| | C | 2.9 | 4.7 |
| | D | 4.7 | 7.6 |
| | E | 7.6 | 12.0 |
| | F | 12.0 | 19.1 |
| | G | 19.1 | 30.7 |
| | H | 30.7 | 49.1 |
| | I | 49.1 | 78.5 |
| | J | 78.5 | 125.7 |
| | K | 125.7 | 201.1 |
| | L | 201.1 | 289.0 |
| | M | 289.0 | 417.0 |
| | N | 417.0 | 680.0 |
| | O | 680.0 | 1100.0 |
| | P | 1100.0 | 1800.0 |
| | Q | 1800.0 | 2700.0 |
| R | 2700.0 | 4300.0 | |
| S | 4300.0 | 6800.0 | |
| T | 6800.0 | 10800.0 | |
| U | 10800.0 | 16000.0 | |
| V | 16000.0 | 25000.0 | |
| W | 25000.0 | 40000.0 | |

Maximum tolerance for each bin limit is $\pm 18\%$.

Color Categories

| Color | Category # | Lambda (nm) | |
|--------|------------|-------------|-------|
| | | Min. | Max. |
| Green | 6 | 561.5 | 564.5 |
| | 5 | 564.5 | 567.5 |
| | 4 | 567.5 | 570.5 |
| | 3 | 570.5 | 573.5 |
| | 2 | 573.5 | 576.5 |
| Yellow | 1 | 582.0 | 584.5 |
| | 3 | 584.5 | 587.0 |
| | 2 | 587.0 | 589.5 |
| | 4 | 589.5 | 592.0 |
| | 5 | 592.0 | 593.0 |

Tolerance for each bin limit is ± 0.5 nm.

Mechanical Option Matrix

| Mechanical Option Code | Definition |
|------------------------|--|
| 00 | Bulk Packaging, minimum increment 500 pcs/bag |
| 01 | Tape & Reel, crimped leads, min. increment 1300 pcs/bag for T-1 3/4, 1800 pcs/bag for T-1 |
| 02 | Tape & Reel, straight leads, min. increment 1300 pcs/bag for T-1 3/4, 1800 pcs/bag for T-1 |
| A1 | T-1, Right Angle Housing, uneven leads, minimum increment 500 pcs/bag |
| A2 | T-1, Right Angle Housing, even leads, minimum increment 500 pcs/bag |
| B1 | T-1 3/4, Right Angle Housing, uneven leads, minimum increment 500 pcs/bag |
| B2 | T-1 3/4, Right Angle Housing, even leads, minimum increment 500 pcs/bag |
| BH | T-1, Tape & Reel, straight leads, minimum increment 2000 pcs/bag |
| FH | Devices that require inventory control and 2 I _v bin select |
| R1 | Tape & Reel, crimped leads, reeled counter clockwise, cathode lead leaving the reel first |

Note:

All categories are established for classification of products. Products may not be available in all categories. Please contact your local Agilent representative for further clarification/information.



Agilent Technologies

www.agilent.com/semiconductors

For product information and a complete list of distributors, please go to our web site.

For technical assistance call:

Americas/Canada: +1 (800) 235-0312 or
(916) 788-6763

Europe: +49 (0) 6441 92460

China: 10800 650 0017

Hong Kong: (+65) 6756 2394

India, Australia, New Zealand: (+65) 6755 1939

Japan: (+81 3) 3335-8152(Domestic/International), or 0120-61-1280(Domestic Only)

Korea: (+65) 6755 1989

Singapore, Malaysia, Vietnam, Thailand,
Philippines, Indonesia: (+65) 6755 2044

Taiwan: (+65) 6755 1843

Data subject to change.

Copyright © 2003 Agilent Technologies, Inc.

September 10, 2003

5988-8054EN